

**NA4908-XL**

## Needle roller bearing

Schaeffler ID:  
0506511960000

Needle roller bearing NA49..-XL, single row, with inner ring, outer ring with 2 bords

X-life

## Technical information

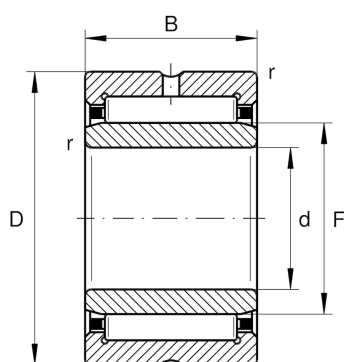
**Main Dimensions & Performance Data**

d	40 mm	Bore diameter
D	62 mm	Outside diameter
B	22 mm	Width
$C_r$	48,500 N	Basic dynamic load rating, radial
$C_{0r}$	67,000 N	Basic static load rating, radial
$C_{ur}$	11,700 N	Fatigue load limit, radial
$n_G$	9,200 1/min	Limiting speed
$n_{gr}$	5,000 1/min	Reference speed
	0.234 kg	Weight

**Dimensions**

F	48 mm	Raceway diameter inner ring
$r_{min}$	0.6 mm	Minimum chamfer dimension
s	1 mm	Axial displacement

**Temperature range**

$T_{min}$	-30 °C	Operating temperature min.
$T_{max}$	120 °C	Operating temperature max.